



110338 G0710

110384 Duplex Test Gauge

July 2006

The duplex gauge is really two separate gauges in one housing. A color coded hose is connected to each gauge with a corresponding color coded pressure indicator hand. The indicators hands use the same common dial which makes it possible to read both simultaneously.

This durable field instrument can be used to check input and output air pressures at various points through out the air system. This can identify air line restrictions, air system imbalances, insufficient air supply pressures, tapped air or leaks.

Checking two separate points in an air brake system against each other will indicate both the amounts of pressure delivered to the test points and their relative time of arrival. This makes the Duplex Test Gauge an invaluable air system troubleshooting device.

110384 Duplex Test Gauge

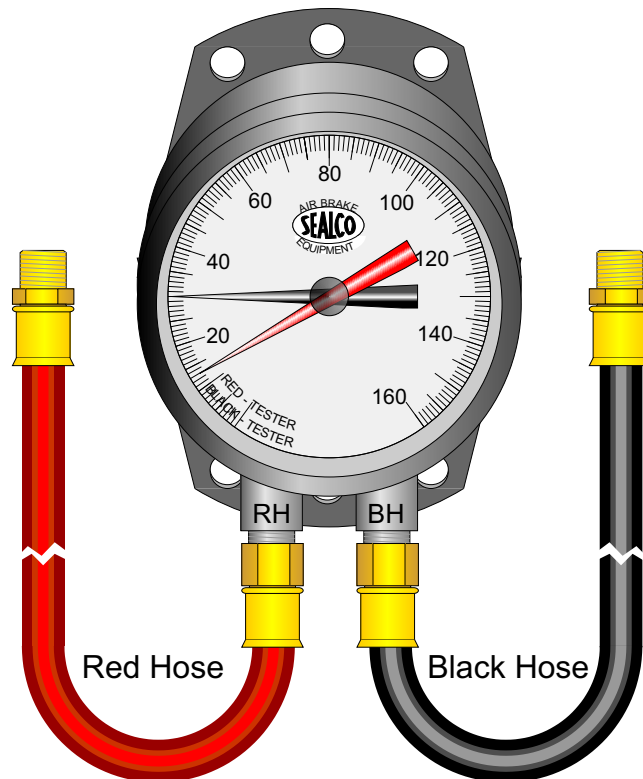

The gauge dial body is 3.5 inches. Each color coded hose is 35 feet long to reach allow use on very long trailers. A diagnostic manual is included.

Testing with the gauge is straight forward. Periodically both hoses should be connected to a common air supply to insure they are reading the same.



110338 G0710

110384 Duplex Test Gauge

July 2006

Problem #1 Tractor Brakes Lead Trailer (Trailer tends to push forward during braking)

Step #1 Connect one test hose to one of the tractor brake chambers (use optional port or tee) Point 1 and the other test hose to one of the trailer brake chambers Point 2. Make a brake application slowly and you can tell immediately whether the brakes of one unit are leading the other, both on application and release.

Step #2 If the dial reading shows tractor brakes ahead of trailer brakes, remove the test hose from trailer chamber, Point 2 and reconnect it in the application port of the trailer relay valve (tee or optional port) Point 3. Make another slow brake application and check to determine if dial reading still shows tractor brakes ahead. If tractor brakes are still ahead, the trailer valve may be eliminated as the source of trouble. If tractor brakes are not ahead at this point, replacement of the trailer valve with a current model will, no doubt, eliminate the problem.

Step #3 If tractor brakes are leading, remove test hose from Point 3 and reconnect it in the application or service line at the gladhand connection Point 4. This may easily be accomplished by making up a double gladhand test unit as shown. Make another slow brake application and check the dial reading. If the reading shows the tractor brakes still ahead, you have eliminated the trailer as the source of trouble. If the reading shows the trailer signal ahead, look for a restriction in the application line between the gladhand and the trailer valve.

Step #4 If tractor brakes are still leading, remove test hose from Point 4 and reconnect it in the trailer application port of the Two-Way Check Valve (transfer valve) at***Point 5. Some 2-way check valves have been found to restrict the application due to design or sludge buildup. Make another slow brake application and check dial reading. If tractor brakes are still ahead, replacement of 2-way check valve is recommended. If dial reading shows trailer brake signal is ahead, the restriction will be found in the line: between the 2-way check valve and the gladhand connection. Look for mashed tube line, defective hose or malfunctioning tractor protection valve and make the necessary replacement.

***Note: Some tractor protection valves (Point 8) have the two way check valves (Point 5) incorporated into one valve .

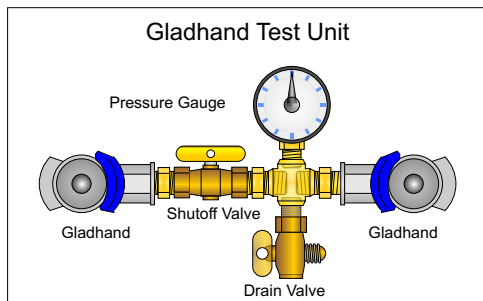
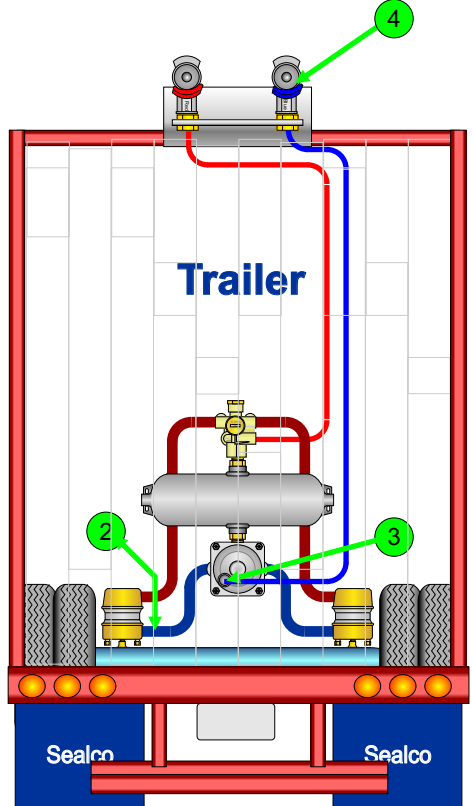
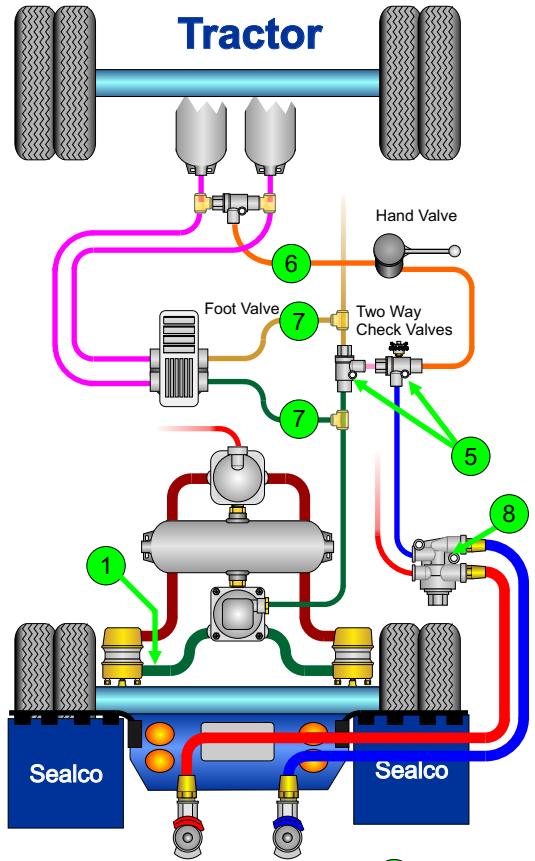



Sealco

Commercial Vehicle Products

215 East Watkins Street Phoenix, Arizona 85004 602/253-1007 Fax 800/222-2334



110338 G0710

110384 Duplex Test Gauge

July 2006

Problem #2 Hand Valve Applies No Brakes But Foot Valve Applies All Brakes

Step #1 Connect one test hose to tractor chamber Point 1 and the other test hose to trailer brake chamber Point 2. Make alternate foot valve and hand valve brake applications to confirm problem. If problem actually exists, disconnect test hose at Point 2 and reconnect to trailer application port of 2-way check valve ***Point 5. Make alternate brake applications again to determine if trailer application pressure is being delivered. If no pressure is delivered, open hand valve application line at 2-way check valve and make hand valve application. If no pressure is delivered, reconnect the line and crack supply line at hand valve to see if reservoir pressure is being supplied to the valve. If reservoir pressure is available at hand valve, replace the hand valve.

Step #2 If no pressure is supplied to hand valve, look for restriction in supply line and make required replacement.

*****Note:** Some tractor protection valves (Point 8) have the two way check valves (Point 5) incorporated into one valve .

Problem #3 Trailer Brakes Release Slow

Step #1 Connect test hoses at Points 2 and 3. Make brake application and observe if dial indicators return promptly and reasonably close together. It is suggested that the Duplex Gauge be held next to the slack adjuster arm so that the dial may be observed as well as slack adjuster return to off position. If indicator hands return promptly and together but slack adjuster arm returns after air is exhausted, look for dry or worn cam shaft bushings, weak chamber or brake shoe return springs, flat spots on cam or brake shoe rollers and/or wear plates, chamber push rod dragging in chamber non-pressure plate hole between mounting studs or frozen brake shoe anchor pins and make suitable corrections.

Step #2 If indicator hands do not return promptly and reasonably close together, remove test hose from Point 3 and reconnect at gladhand connection Point 4. Make a brake application and observe indicators again. If indicators return promptly and together, look for a restriction between the gladhand and the trailer valve. It may be necessary to check this line at each line splice to find and replace the restricted portion.

Step #3 If indicator hands do not return promptly and together, disconnect test hose at Point 4 and reconnect at trailer port of 2-way check valve Point 5. Retest at this point and replace 2-way check valve if release is slow. If release is normal at this point, the restriction will be located in the line between the 2-way check valve and the gladhand connection. This may be caused by malfunction of the tractor protection valve or a defective brake hose. Sometimes a piece of hose liner may break loose and allow air flow one way but will act as an effective 2-way check valve when air flow is reversed and forcing the flap across the hole.

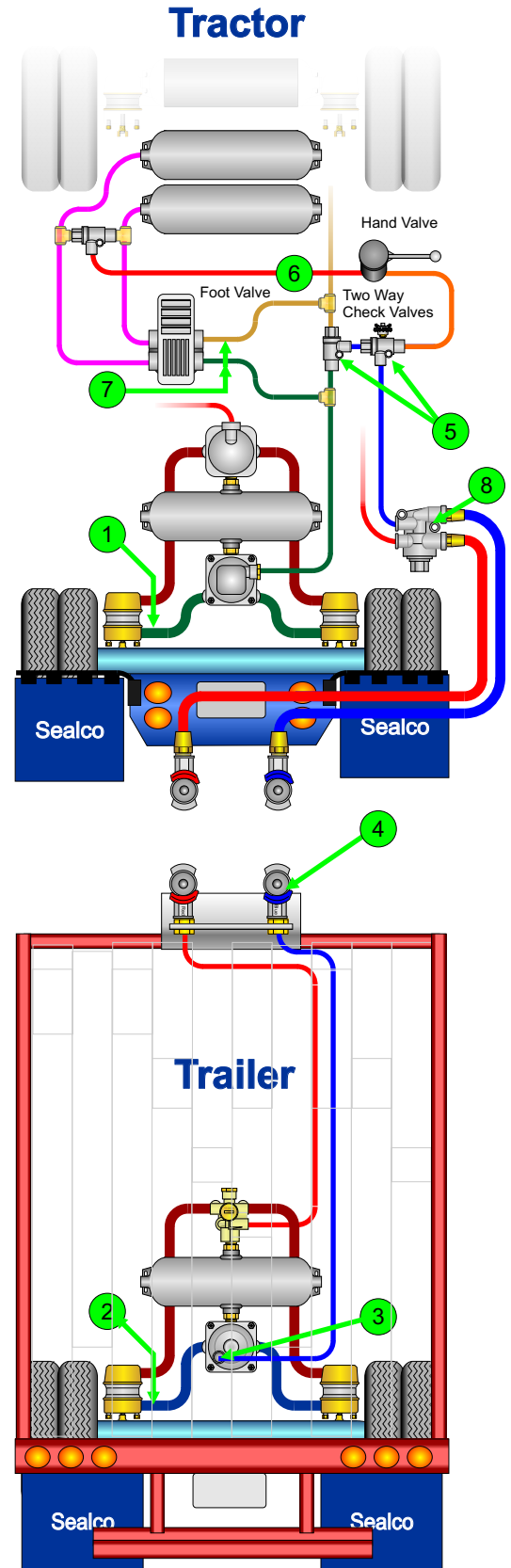



Sealco

Commercial Vehicle Products



215 East Watkins Street Phoenix, Arizona 85004 602/253-1007 Fax 800/222-2334

110338 G0710

110384 Duplex Test Gauge

July 2006

Problem #4 Not Enough Brake Reaction

With 120 PSI Shown On Dash Gauge

- Step #1** Drain air reservoir and connect one test hose into optional port of reservoir or manifold fitting Point 6. Build up air pressure and check reading with that of dash gauge to determine if the pressure shown is correct.
- Step #2** If pressure readings are comparable, connect the other test hose to the tractor brake chamber Point 2. Make a brake application to determine if the application valve is delivering reservoir pressure. Some of the older style foot valves were made to deliver approximately 80% of reservoir pressure.
- Step #3** If foot valve delivers reservoir pressure to the brake chamber look for defective foundational part(s) (slack adjusters, s-cams or bushings, brake shoes, drums). Also check for kinked or damaged delivery hoses.
- Step #4** If foot valve does not deliver adequate pressure, disconnect test hose at Point 1 and reconnect it to any foot valve outlet port Point 7. Make a brake application. This will establish if the valve is delivering required pressure. Remote mounted valves may be losing application capabilities due to lost motion in mechanical linkage between cab pedal and the valve. If linkage has minimum of lost motion and valve does not deliver sufficient pressure, replace the valve.

Problem #5 Large Reservoir Pressure Drop

Below 30 PSI With Each Brake Application

- Step #1** Be sure all foundational brake parts are working and adjusted properly. Stop engine and make brake application to determine if pressure drop has been reduced. If pressure drop has not been reduced, make brake application, with engine stopped, and hold the application, check cab gauge to determine if pressure continues to fall on sustained application. If it does, look for system leaks by painting all piping connections and chamber diaphragm outer circle with liquid soap.
- Step #2** Make another sustained brake application and have another observer listen at all valves for leaks at these points. Also have observer look for air bubbles at piping connections.
- Step #3** If no system leaks are found or they do not drop pressure on sustained application more than five pounds in one minute, drain reservoir by opening drain cock and leaving it wide open until all condensations and sludge finishes draining out. If a great deal of material drains out, the trouble may have been caused by the reduction of area in the reservoir. Start engine and rebuild pressure. Recheck pressure drop.
- Step #4** If the problem still exists, contact manufacturer about whether a larger or additional reservoir might be required.

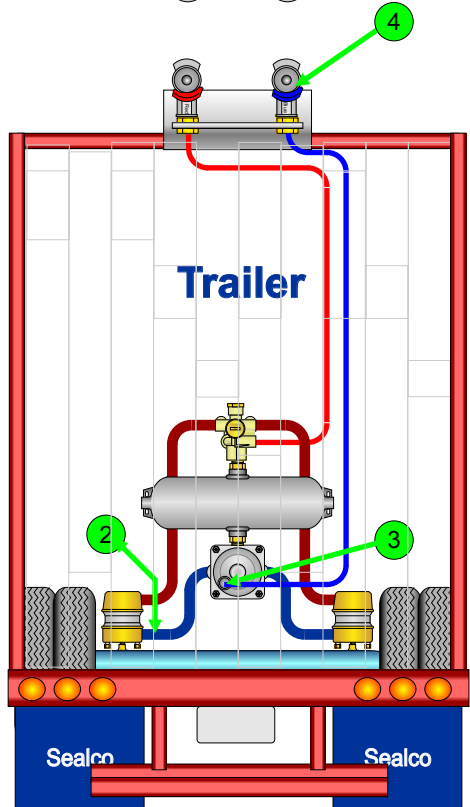
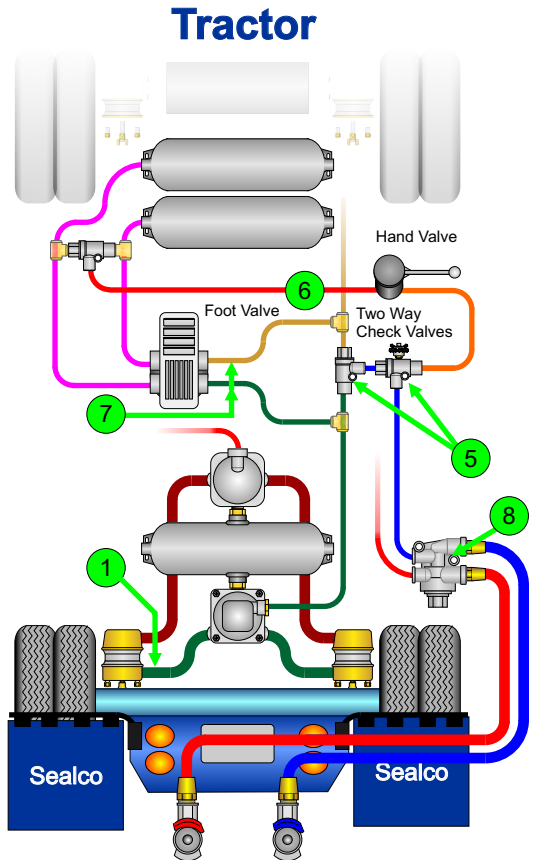



Sealco

Commercial Vehicle Products

215 East Watkins Street Phoenix, Arizona 85004 602/253-1007 Fax 800/222-2334



110338 G0710

110384 Duplex Test Gauge

July 2006

Problem #6 Hand Valve Does Not Apply Brakes Even Though Foot Valve Works Correctly

Step #1 Connect one test hose to tractor chamber Point 1 and the other test hose to trailer brake chamber Point 2. Make alternate foot valve and hand valve brake applications to confirm problem. If problem actually exists, disconnect test hose at Point 2 and reconnect to trailer application port of 2-way check valve Point 5.

Make alternate brake applications again to determine if trailer application pressure is being delivered. If no pressure is delivered, open hand valve application line at 2-way check valve and make hand valve application. If no pressure is delivered, reconnect the line and crack supply line at hand valve to see if reservoir pressure is being supplied to the valve. If reservoir pressure is available at hand valve, replace the hand valve.

Step #2 If no pressure is supplied to hand valve, look for restriction in supply line and make required replacement.

General Air Braked Vehicle Tests

- #1 Pressure Loss**
Pump up pressure to normal governor cut-out point. Stop engine and fully apply brake after pressure has equalized for one minute. Pressure drop should not be more than 3 pounds for single vehicles or more than four pounds for vehicle combinations.
With engine stopped and brakes released pressure drop should not exceed two pounds in one minute or more than three pounds for combinations.
- #2** Do not attempt to make further tests unless low pressure indicator has ceased to function.
- #3** When tractor is attached to trailer, check cab control valve setting to be sure trailer is supplied air for its use.
- #4** Activate cab control valve to cause trailer emergency brake application. Return cab control valve to normal position to release trailer brake application.
- #5** Before vehicle or combination is driven off lot, apply foot valve to test brakes.

